

WeatherTech®



WHOLESALE CATALOG



Made in USA

Discover iconic products your customers ask for by name



PROTECTING WHAT MATTERS

I've always been passionate about supporting the American economy and preserving our industrial infrastructure. My philosophy is that if my neighbor doesn't have a job, sooner or later I probably won't have a job either. At WeatherTech, we design, engineer and manufacture right here in America, so you can trust that we're using the best materials, leveraging leading edge technologies and innovations, and hiring skilled and educated workers to create world-class products.

By creating our products here in the U.S., we also have better line of sight to initiatives that are just as important to me as job creation — human and animal rights, safe workplace practices, environmental responsibility and more.

Now more than ever, we need to support each other in getting our economy up and running again. That's why WeatherTech is an American business that supports other American businesses like yours. It's our responsibility to work together to help each other succeed, and help our country recover. American-made goods and services directly support the U.S. economy and, in turn, our broader partners of 330 million Americans.

Life is simple; be good to your fellow man, be kind to animals, respect our environment, and put building a quality product and supporting American workers before making profits. We take pride in knowing that WeatherTech will always help lead the way.

Sincerely,

David MacNeil, WeatherTech Founder and CEO





CONTENTS

INTERIOR PROTECTION

FloorLiner™	6
FloorLiner™ HP	8
All-Weather™ Floor Mat	10
Cargo/Trunk Liner	12
Bumper Protector	12
SeatBack Cargo Liner HP	13
Trim-to-Fit™ Floor Mat	14
Trim-to-Fit™ HD Floor Mat	14
Trim-to-Fit™ Cargo Mat	14
Seat Protector	16
Door Protector	16
Seat Back Protector	17
SunShade™	18
Under Seat Storage System	20
CargoTech®	22
CarCoasters™	23

EXTERIOR PROTECTION

TechLiner®	24
Tailgate TechLiner®	24
UnderLiner®	25
Kinetic Recovery Rope System	25
Roll Up Truck Bed Cover	26
AlloyCover™	27
Side Window Deflector	28
Sunroof Wind Deflector	28
No-Drill MudFlap	29
Stone & Bug Deflector	30
Hood Protector	31
License Plate Frames	33
BumperTopper™	34
BumpStep®	35
BumpStep®XL	35
Billet BumpStep®	35
Billet BumpStep®XL	35
ScratchProtection	36
Prep/Tack and Slip Solution	36
LampGard®	37

VEHICLE CARE & ACCESSORIES

Golf Cart Mat	38
TechCare® Cleaning and Detailing Products	39
TechCare® Conditioning Products	40
TechCare® Accessories	41
Custom-Fit Car Covers	43
FuelGlove™	44
BatteryCharger	44
Door Pocket Hand Sanitizer Holder	45
RackSack®	45

MOBILE DOCKS & ACCESSORIES

CupFone®	46
CupFone® Two View	46
CupFone®XL	46
CupFone® Duo	47
CupFone® Accessories	49
DeskFone®	50
DeskFone® Two View	50
DeskFone® XL	50
DeskFone® Accessories	51
MirrorFone™	52
Rotating MirrorFone™	52
Rotating MirrorFone™ XL	52
MirrorFone™ Two View	52
TabletHolder™	55

HOME & BUSINESS

OutdoorMat™	56
IndoorMat™	56
BootTray™	56
ComfortMat™	58
ComfortMat™ Connect	59
SinkMat™	60
Christmas Tree Mat	61
All-Purpose Mat	61
Coasters	62
FlexTray®	62
SoapSaver™	63
RazorHolder™	63
TechFloor™	64
FaceShield Air™	65
StarBelt®	65

PET PRODUCTS

Pet Feeding System	66
PetRamp™	68
EasyRamp®	69
Pet Partition	70
Pet Safety Harness	71
Pet Barrier	71

WHOLESALE EXCLUSIVE

Wholesale Programs	72
--------------------	----



INTERIOR PROTECTION



Available in Black, Tan, Grey and Cocoa



Front over-the-hump FloorLiner™



Rear over-the-hump FloorLiner™

FloorLiner™

The iconic, laser-measured vehicle floor mat that provides Absolute Interior Protection™ and preserves virtually any vehicle's resale value.

Raised lip traps spills and splashes

Features a textured, soft-touch surface and contoured underside for grip and friction

Manufactured in the USA from a proprietary custom-blended wear-resistant thermopolyolefin

Channels carry fluids away from shoes and carpet



Large Gift Bag

INTERIOR PROTECTION



Available in Black, Tan, Grey and Cocoa

Optional trim line for sill plate (if applicable)



Anti-skid nibs

FloorLiner™ HP

The next generation of high-performance FloorLiner™. All the features your customers love about the original FloorLiner™ with upgrades to provide even more high-quality coverage.

High-walled design helps contain messes of any kind

Made from advanced rubber-like thermoplastic elastomer (TPE)

Anti-skid nibs and underside texture keep the mat in place

Where applicable, a watertight seal around retention devices helps prevent leakage

Custom fit for superior protection



INTERIOR PROTECTION



Available in Black, Tan, Grey and Cocoa

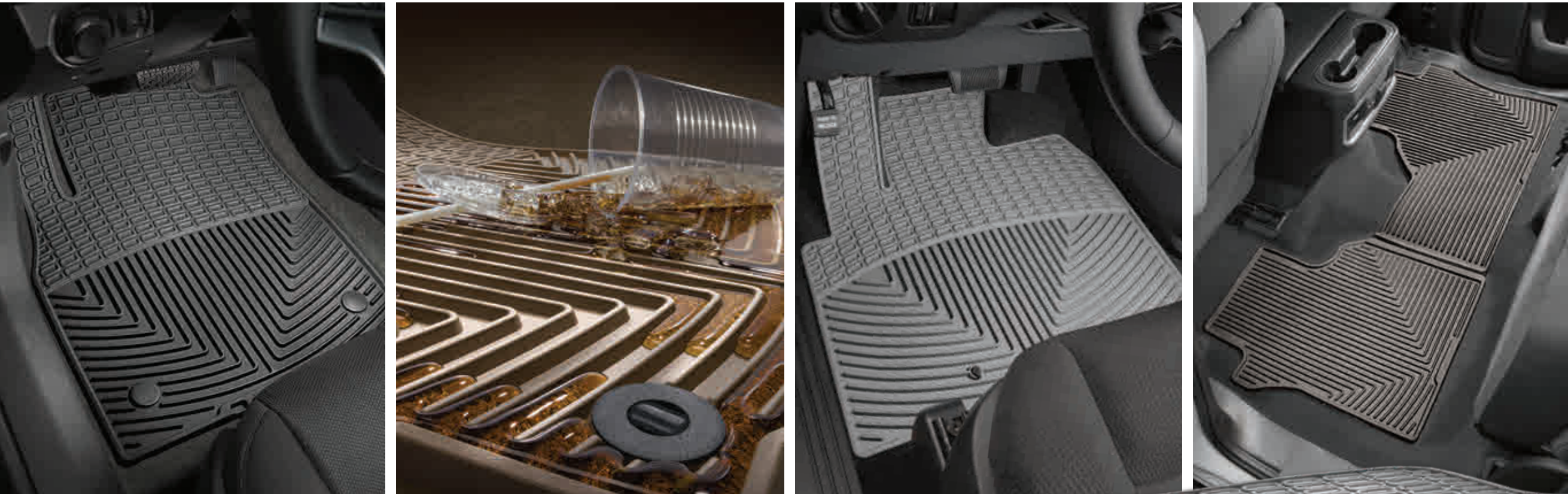

All-Weather™ Floor Mat

With deeply sculpted channels that trap water, road salt, mud and sand, this mat stands up to even the most extreme weather.

Will not crack, curl or harden

Environmentally safe, 100% recyclable material

Available for virtually any vehicle

Proudly designed and manufactured in the USA



INTERIOR PROTECTION

Cargo/Trunk Liner

A laser-measured liner for any trunk or cargo area. Features a raised lip for catching and containing water, spills, dirt, grease and more.



Available in Black, Tan, Grey and Cocoa



Bumper Protector

Bumper Protector attaches to the Cargo/Trunk Liner and protects the bumper's surface from dings and scratches when loading or unloading groceries, gear or pets.

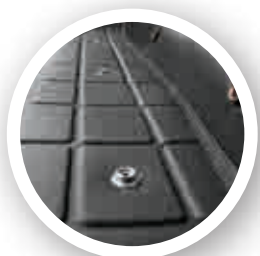

Easily attaches to Cargo/Trunk Liner by four pre-installed snaps



Rolls up easily when not in use



SeatBack Cargo Liner HP

The one-piece SeatBack Cargo Liner HP provides complete, custom-fit protection for vehicle cargo areas — including the back of the last row of seats. Our patent pending, expandable accordion hinge even allows for back seats to go in the full-down position while maintaining full coverage.

One-piece mat ensures expansive coverage by lining the cargo area and the back of the last row

Custom fit to year, make and model

Water retention ribbing system traps water

Non-slip nibs and hook and loop fasteners on the underside keep it in place

Easy to install and remove for cleaning



Available in Black, Tan, Grey and Cocoa



Heavy-duty option available



INTERIOR PROTECTION



Available in Black, Tan and Grey;
HD Floor Mat Only in Black

Trim-to-Fit™ Floor Mat



Available in 4-piece or 3-piece sets

Trim-to-Fit™ HD Floor Mat



Available in 4-piece set

Trim-to-Fit™ Cargo Mat



Trim it to fit it – we make it simple for the customer. Our customizable mats lead the market in technology, design and practicality, allowing for a fit that is truly precise.

Outer ridge and reservoir trap and contain fluid

Patented TechGrip® II prevents shifting

Won't crack, curl or harden



TechGrip® II

Trim-to-Fit™ Floor Mats are also available in a 3-piece over-the-hump rear option.



INTERIOR PROTECTION



Available in Charcoal, Cocoa, Tan and Grey

Seat Protector

Water repellent and machine washable, Seat Protector allows your customers to protect and preserve the resale value of their vehicles by keeping seats in pristine condition. Available for both front and rear, bucket or bench seats.



Bucket Seat Protector



Non-slip cover

Door Protector

Protects interior door panels from scratches and slobber with a durable coated fabric shield. Sold as a pair and machine washable.



Seat Back Protector

The first line of defense against scuffs and marks taking a toll on vehicle seat backs. Plus, with four built-in pockets, organization is a breeze. Easy to clean with a wet wipe.



18½" x 23½"



INTERIOR PROTECTION



Cool down in the summer

Tackle frost in the winter



SunShade™

Custom-fitting, dual-purpose window shade that keeps vehicles cool in summer and helps to prevent frost build-up in winter. Made in USA.

Foam core center provides a sturdy fit

Easily removes and stows in an optional storage bag

Full vehicle kits available for select applications



INTERIOR PROTECTION

Under Seat Storage System



Custom-fit, easy-to-install truck organizer that fits under the rear seating bench. Keeps items stored out of sight.

Installs in minutes without drilling or chemicals

Built-in dividers help prevent cargo from shifting

Made from 100% recyclable material



INTERIOR PROTECTION



CargoTech®

A cargo containment system that prevents cargo from shifting or tipping over while driving.



CarCoasters™

Removable coasters for cup holders that make for easy cleaning.



EXTERIOR PROTECTION



TechLiner®

A custom-fit pickup truck bed liner that protects and shields the truck bed against scratches, dents, paint damage and rust. Installs without drilling.



Tailgate TechLiner®

Extends the protection offered by TechLiner® to the tailgate.

UnderLiner®

Provides a semisoft protective barrier between a "drop-in" style bed liner and the painted surface of the truck's bed.



Kinetic Recovery Rope System

Recover vehicles up to 9,433 lbs. from snow, mud and sand by harnessing the power of kinetic energy. A must-have in any vehicle emergency kit, from off-roaders to everyday drivers.

Measures 7/8" thick and 20' long

Double-loop soft shackles



EXTERIOR PROTECTION

Roll Up Truck Bed Cover

A custom-fit, lightweight tonneau cover made from commercial grade, reinforced vinyl. Its heavy-duty, water-resistant design protects cargo from tough weather.



AlloyCover™

A durable yet low-profile, tri-fold tonneau that protects cargo and offers maximum security.



EXTERIOR PROTECTION



Side Window Deflector

Custom-fit, in-window-channel rain guards that let fresh air in and keep rain out.

Available for Front and Rear Windows

Sunroof Wind Deflector

Easy to install deflector that reduces wind noise in the vehicle.



No-Drill MudFlap

Laser-measured MudFlaps that install without the need for wheel/tire removal or drilling. Proudly designed and manufactured in the USA.



Prevent stone chips, slush and debris from damaging the fender and rocker panel

Feature a patented QuickTurn™ stainless steel fastening system

Mounts-In-Minutes™

EXTERIOR PROTECTION

Hood Protector

The ultimate protective hood accessory with a sleek, low-profile design.



Stone & Bug Deflector

Sleek, rock and bug shield to protect the hood from dings, dents and bug stains.



EXTERIOR PROTECTION



License Plate Frames

PlateFrame®

A thermoplastic license plate frame minus a gasket. Offers optimum resistance to weathering.

ClearFrame™

Features a Multi-Flex™ rubber gasket that seals out moisture and is gentle on the surface of the car.

ClearCover®

All the features of ClearFrame plus a UV coated, clear acrylic lens that shields the license plate from the elements.

StainlessFrame™

A solid stainless steel license plate frame, featuring a PlateSpacer® gasket to support the frame away from the car's body.

BumpFrame®

A higher-profile and impact-resistant license plate frame design that shields the bumper from damage.

Billet Aluminum

A license plate frame that's CNC machined from American-sourced raw billet aluminum to ensure a beautiful, durable and seamless design.

Titanium

A license plate frame that's CNC machined from American-sourced titanium — one of the strongest materials in the world.

Carbon Fiber

A license plate frame manufactured using real 3K carbon fiber for durability and a sleek appearance.

Motorcycle Billet Aluminum

A license plate frame that's CNC machined from American-sourced raw billet aluminum; an ideal statement piece for motorcycles.



Multiple colors and finishes are available for both ClearFrame™ and ClearCover®.

DID YOU KNOW?



Molded from a patented composite resin.



EXTERIOR PROTECTION

Fits any standard 2" hitch receiver

Bumper Solutions

A hitch-mounted solution to defend bumpers from costly dents, cracks and scratches caused by minor rear end accidents. Doubles as a step to reach the vehicle's roof.

BumpStep®

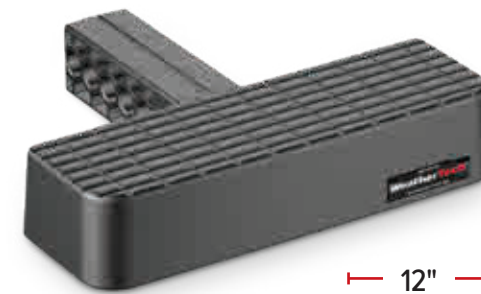

12" Width

Billet BumpStep®



12" Width



BumperTopper™

A rear bumper guard that shields rear bumpers from scratches, scuffs, paint chipping, wear and damage caused by everyday loading and unloading.

BumpStep® XL

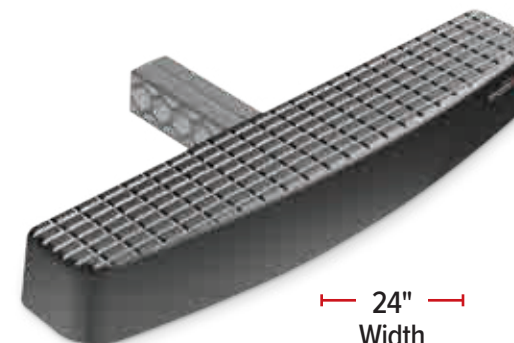

24" Width

Billet BumpStep® XL



24" Width

EXTERIOR PROTECTION

ScratchProtection

Invisible, high-performance film that shields door handles, edges, trunk ledges and other areas from scratches and wear.



Prep/Tack and Slip Solution

Designed to simplify the preparation and application processes for our protective film products.



LampGard®

Invisible, protective film designed to prevent scratches and wear in vehicle headlights, fog lamps and parking lights.

Easy to install

Resistant to discoloration from lamp light

ScratchProtection and LampGard® do not require cutting — they are custom fit to the vehicle make and model.





Golf Cart Mat

Shields golf cart floors from scratches and spills. A patented cleat cleaner allows for easy cleanup of mud and grass from shoes, while side vents help drain water away for a drier ride.



VEHICLE CARE & ACCESSORIES



TechCare® Cleaning and Detailing Products



FloorLiner™ & FloorMat Cleaner

Interior Detailer

Carpet Cleaner with SpotTech™

Interior Glass Cleaner with Anti-Fog

Acid-Free Wheel Cleaner

Heavy Duty Wheel Cleaner

Gentle Car™ Shampoo

Wax-Prep Clay Gel Cleaner

Exterior Glass Cleaner with Repel

VEHICLE CARE & ACCESSORIES

TechCare® Conditioning Products



FloorLiner™ & FloorMat Protector

QuikTech™ Detailer with Carnauba Wax

Carnauba Gel Wax

Leather Conditioner with Aloe Vera

Tire Gloss with Cross-Link Action™

TechCare® Accessories



Microfiber Applicator & Cloths

Preferred by car enthusiasts for their soft touch, absorbency, and effective cleaning and drying properties.



WashMit™

Lifts and traps grime while washing. Features a wrist cuff to keep mitt securely in place.



Ready to Wash™ System

All-in-one system includes a bucket, Roll & Wash dolly, vented lid seat and insert that filters debris from wash water.



Soaker™

Quickly absorbs water without leaving streaks or lint behind.



WaterBlade™

Post-wash wiper blade that significantly reduces drying time after washing or rain. Made from non-scratch silicone.

VEHICLE CARE & ACCESSORIES

Custom-Fit Car Covers



Outdoor Car Cover

Allows your customers to winterize their vehicles outside in snowy climates and protect from UV fading in the summer with this heavy-duty cover.



Indoor Car Cover

A luxuriously soft, form-fitting car cover for off-season safekeeping indoors.

UV resistant and withstands harsh climates

Comes with two storage bags

Sewn-in vehicle ID tag to easily find the right cover

VEHICLE CARE & ACCESSORIES



FuelGlove™

A protective glove to use while pumping gas, featuring a FastFit® slip-on design.



Door Pocket Hand Sanitizer Holder

Conveniently clips to the door pocket or seat back for germ protection on the go.



BatteryCharger

A 4 Amp 12V/6V switchable battery charger designed to lengthen the life of batteries through its high-performance charging functions. Easy to use and operate, and is engineered to withstand harsh weather conditions.



RackSack®

A rooftop weather-resistant cargo carrier that helps secure excess gear on the roof of the vehicle safely.



MOBILE DOCKS & ACCESSORIES



Interchangeable base cups provide a precise fit

Adjustable to the perfect screen view

Allows phone to charge while in the holder

BESTSELLER



CupFone®

The original, bestselling in-vehicle mobile phone holder.



CupFone® Two View

Width adjusts to view the phone in portrait or landscape mode.



CupFone® XL

The same great features as CupFone® but designed for oversized phones or cases.



CupFone® Duo

Two heads are better than one with the CupFone Duo. Featuring all the great benefits of CupFone, plus an additional phone holder for passengers to store their device, this dual-mounted dynamo fits into virtually any cup holder.

MOBILE DOCKS & ACCESSORIES



CupFone® with Hand Sanitizer Holder



CupFone® Accessories

Extension

Allows the customer to position their phone up to 4" closer/further away for the optimal viewing angle.

Billet Knobs

Accessorize the CupFone® with aluminum Billet Knobs in a variety of colors.

Storage Bag

A convenient pouch to store CupFone® and accessories while traveling or switching vehicles.



Small Gift Bag

The perfect way to disguise a CupFone® gift; plus, the recipient can repurpose as a storage bag.

Hand Sanitizer Holder

Ensure PURELL® Advanced Hand Sanitizer is always in reach with this handy holder made just for CupFone®.

StickySleeve™

A rubber sleeve that offers additional stability for CupFone®.



Works in boats, golf carts, RVs and more.

DID YOU KNOW?



DeskFone[®] Two View

Width adjusts to view the phone in portrait or landscape mode in this model of DeskFone[™].

DeskFone[®]

Mobile phone holder that tilts and adjusts for the perfect viewing angle. Non-slip feet keep it steady, and its open design allows the phone to be charged in place.

DeskFone[®] XL

The same great features as DeskFone but fits oversized or larger phone cases.



All DeskFone[™] Models are Available in Black or White

MOBILE DOCKS & ACCESSORIES

DeskFone[®] Accessories

Billet Knobs

Accessorize, customize and personalize any DeskFone[™]. Multiple colors available.



Small Gift Bag

The perfect way to disguise a DeskFone[®] gift.



MOBILE DOCKS & ACCESSORIES

MirrorFone™



Rotating MirrorFone™



Rotating MirrorFone™ XL



MirrorFone™ Two View



WeatherTech offers four uniquely customizable MirrorFone options! Each mounts mobile devices to virtually any flat, smooth surface for ease of use.

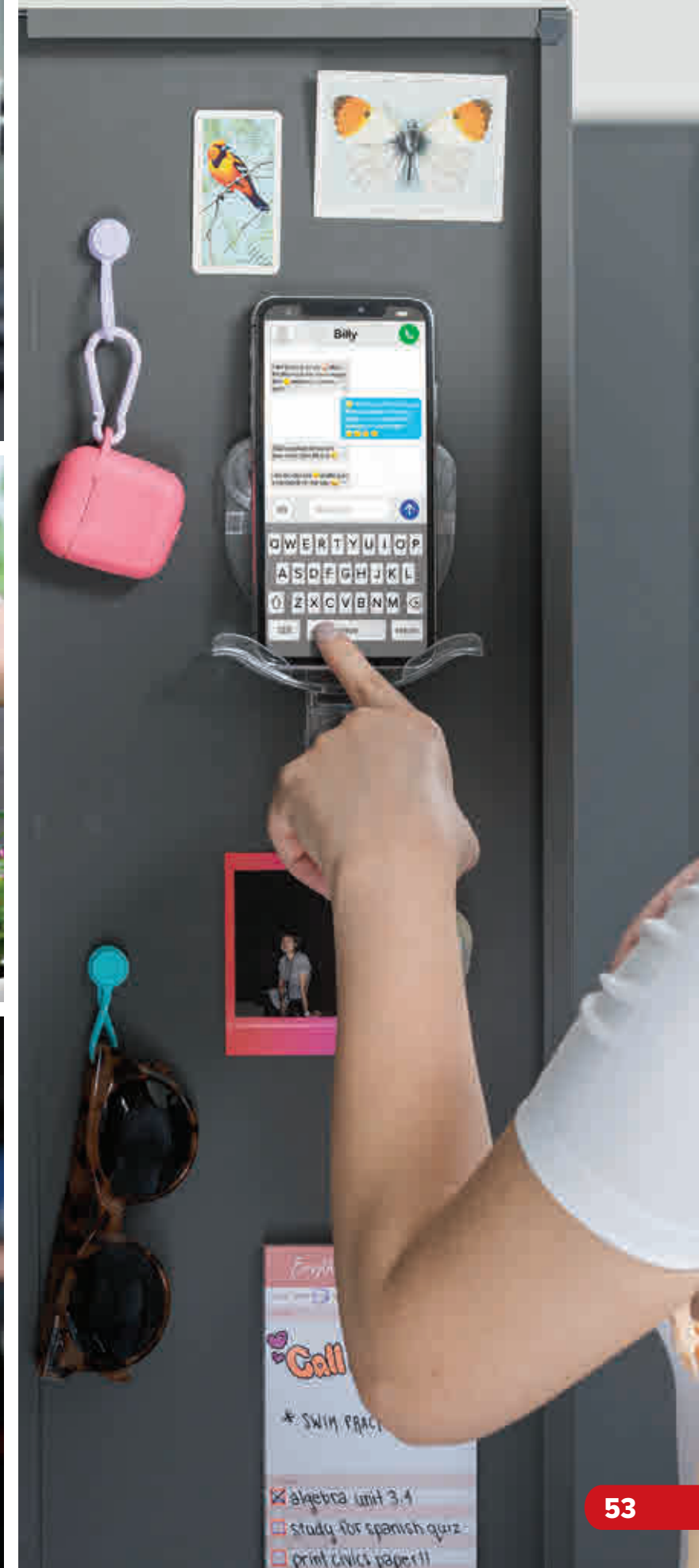



MOBILE DOCKS & ACCESSORIES



TabletHolder™

The WeatherTech TabletHolder fits iPad, Amazon Fire HD, Samsung Galaxy Tab or virtually any tablet on the market.

Features an easy-grip knob that rotates to change viewing angle

Unique cable weave on the rear foot secures charging cable while in use



Available in Black, Grey and Red



HOME & BUSINESS

OutdoorMat™



A durable mat that works outside in any season. Its useful design features semi-rigid cones to remove mud and debris from footwear.

Available in Black, Tan, Grey, Brown and Cocoa

IndoorMat™



Your customers can protect their home or business from tracked-in messes with this digitally designed mat made from 100% recyclable resin.

BootTray™



A smart solution for storing wet, snow covered shoes. This tray traps and contains water and easily holds four large pairs of boots or shoes.





ComfortMat™

Maximum comfort, support and cushion provides relief for anyone standing for long periods of time in the kitchen, laundry room, workshop, at standing desks – or any hard floor.



Textured surface and underside offer added traction and grip



Available in Black, Tan, Grey and Cocoa

ComfortMat™ Connect

This expandable anti-fatigue mat starts with two 3-foot end pieces that snap together to create a 6-foot long ComfortMat Connect. Extend it with middle pieces — or even connect it around corners with corner pieces. It's up to your customer, their space and their imagination.

Available in Black, Tan, Grey and Cocoa





SinkMat™

A trimmable, waterproof mat to protect kitchen or bathroom vanity cabinets from plumbing leaks and product spills.

Available in Black or Tan



Christmas Tree Mat

Keep floors protected from water, pine needles and broken ornaments with this mat, offering 360-degree coverage.

Available in Black, Dark Green, Cocoa and Terra Cotta



All-Purpose Mat

The ultimate protection for everyday living. This durable mat has hundreds of uses in the home, garage and even outdoors.

Available in Black, Tan, Grey, Brown and Cocoa



Works great beneath high chairs



HOME & BUSINESS



Coasters

Protect home surfaces with durable, made in the USA coasters. Available in a variety of sizes and colors.



SoapSaver™

Makes bar soaps and sponges last longer. Available in two options—shower or sink—and two colors—clear or white.



FlexTray®

Multi-use, foldable small tray with hundreds of organizational and protective uses at home or on the go.



RazorHolder™

Stores razors safely and at the ready, in the shower or by the sink. Holds two razors and adheres to bathroom walls, glass and mirrors with two durable adhesive strips.





TechFloor™

Modular, heavy-duty flooring solution that transforms garages, workshops, laundry rooms or workout rooms.

Available in a Variety of Colors

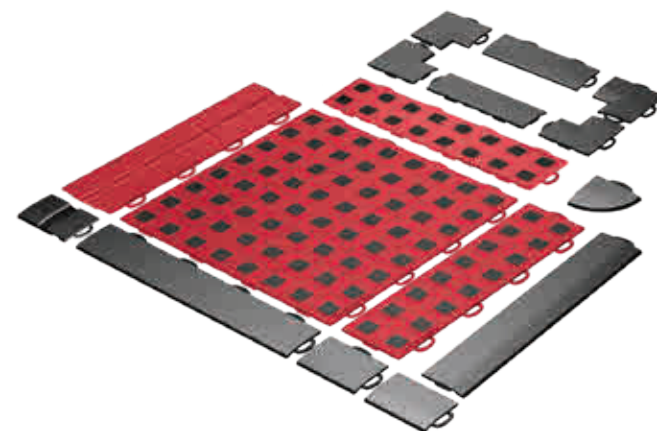

FaceShield Air™

Your customers will get the extra layer of security they need to get through their day with WeatherTech's FaceShield Air.

Removable and washable ComfortPad

Disposable, anti-fog lens

Lens refills available in two lengths



StarBelt®

A trendy, metal-free, TSA-friendly belt with interchangeable buckles that is perfect for sports and travel.

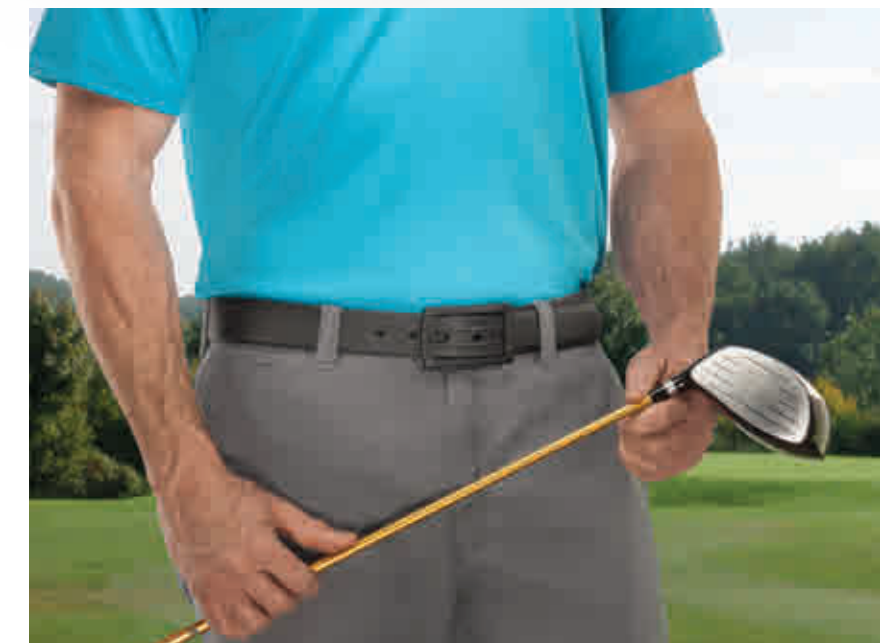



Pet Feeding System

An innovative, customizable feeding system featuring non-toxic, BPA-free plastic or American-made stainless steel ergonomic bowls that are dishwasher safe.

Available in Tan, Light Grey and Dark Grey, as Well as a Variety of Heights and Bowl Sizes



PET PRODUCTS



Supports up to 300 lbs.

PetRamp™

A lightweight, foldable ramp that helps pets safely and easily enter higher vehicles.



EasyRamp®

The same great features as PetRamp but with a center "stool" that provides a gentler incline. Great for pets with mobility issues and offers easier access to higher vehicles.



Pet Partition



Limit driving distractions by keeping pets in the vehicle's back seat area. This heavy-duty mesh barrier is a universal fit for any vehicle.

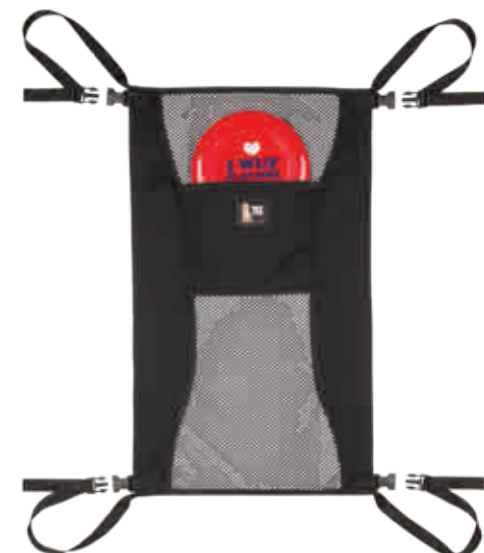

Pet Safety Harness



A seat belt for your pet that is quick to take on and off and provides maximum security while driving.

No additional attachments required



Pet Barrier



An adjustable and expandable heavy-duty barrier that keeps pets safely secured in the rear of the vehicle.

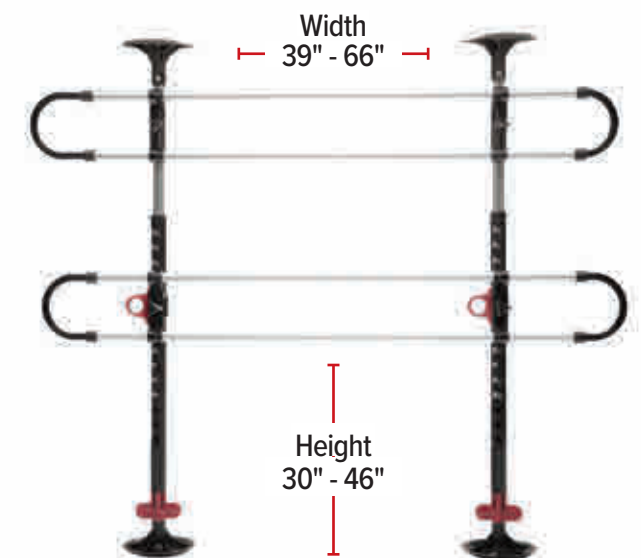

WHOLESALE PROGRAMS

Discover a premium platform to grow your business.

WeatherTech® is the industry leader, because we invest significant resources to offer your customers and end users the highest quality products, with world-class service. We're driven by partnerships with trusted resellers and distributors like you, so why not team up so we can both succeed?

Join one of our outstanding wholesale programs today and take advantage of these benefits, and many more!

- Preferred placement on WeatherTech's Dealer Locator
- POP display materials
- Direct email with new product updates
- WeatherTech Reseller Program Member sign
- Marketing support and exclusive promotions
- A true partnership with a brand that your customers are asking for by name

Place one of these qualifying orders to cash in on the benefits of partnering with WeatherTech.

DIAMOND DEALER



- (6) FloorLiner™ or FloorLiner™ HP (front or rear)
- (4) No-Drill MudFlaps

Plus choose ONE of the following

- (2) Under Seat Storage Systems
- (2) Side Window Deflectors (front or rear) or mix & match any 3

- CargoTech®
- BumpStep®
- BumpStep®XL
- License Plate Frames
- TechCare®
- CupFone®

RV PROGRAM

- (5) FloorLiner™ or FloorLiner™ HP (front or rear)

Plus mix & match any 10

- CupFone®
- BumpStep®
- CargoTech®
- SunShade™
- No-Drill MudFlaps
- IndoorMat™/OutdoorMat™
- BootTray™
- TechCare®
- Coasters

HEAVY DUTY TRUCK PROGRAM

- (6) FloorLiner™ and (4) CupFone®

Plus mix & match any 3

- BumpStep®
- Seat Protector
- SunShade™
- TechCare®
- LampGard®
- FuelGlove™

UNIVERSAL RESELLER



- (9) Trim-to-Fit™ 4-piece, 3-piece, or HD Floor Mats
- (3) Trim-to-Fit™ Cargo Mats

ESSENTIALS RETAILER



- (9) IndoorMat™/OutdoorMat™/ComfortMat™ or BootTray™

Plus choose either:

(6) of ONE or (3) of TWO products

- SinkMat™
- All-Purpose Mat
- Christmas Tree Mat
- Coasters
- FlexTray®
- SoapSaver™
- Child Car Seat Protector
- Seat Protector
- Seat Back Protector
- Door Protector
- RackSack®
- TechCare®
- CargoTech®
- Pet Barrier
- BumpStep®
- BumpStep® XL
- BatteryCharger
- License Plate Frames
- CupFone®
- DeskFone®
- TabletHolder™

MARKETING MATERIALS

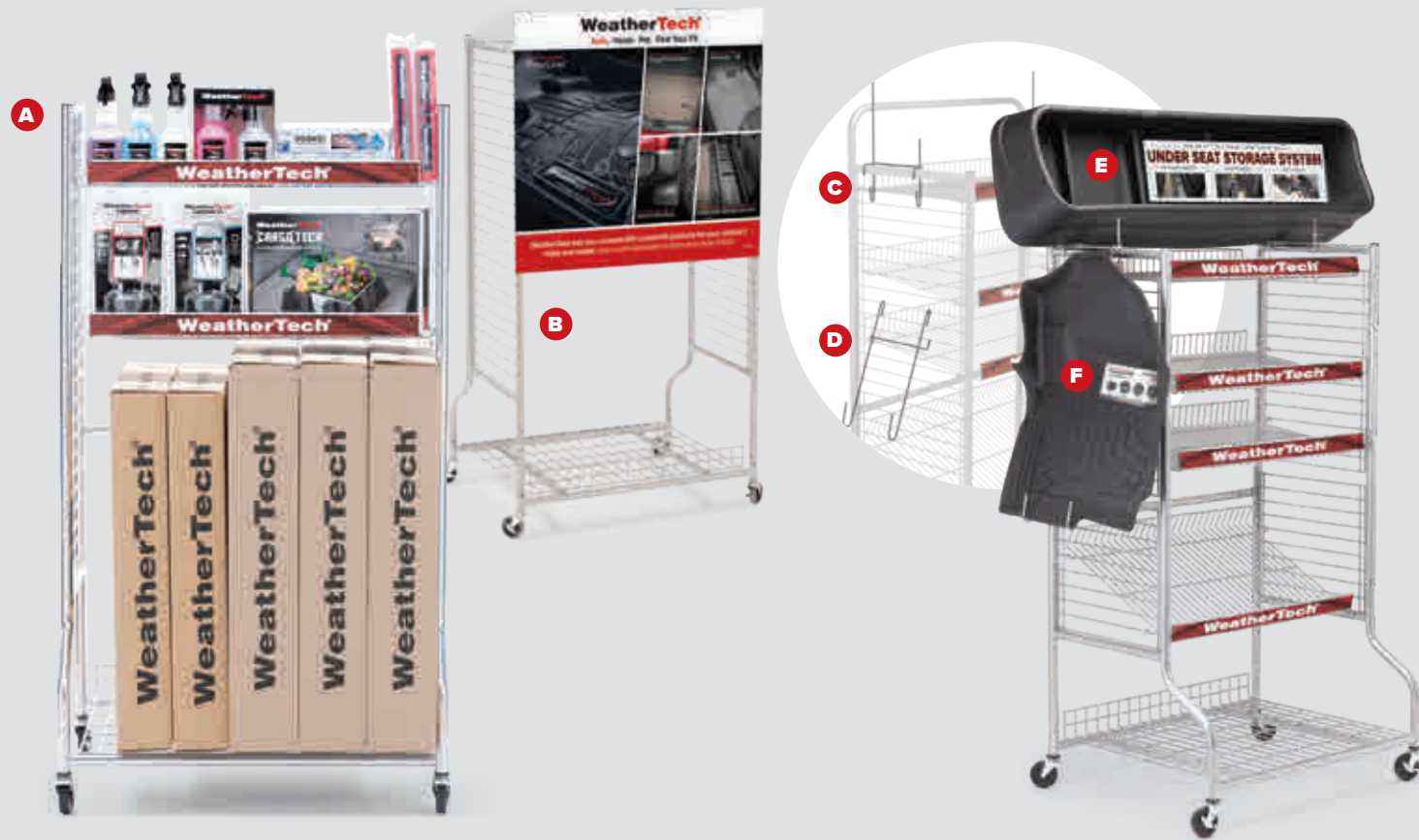

- A Adjustable Universal Display**
60" x 33" x 19"
152.4 cm x 83.82 cm x 48.26 cm
99996
4 Shelves Included
- B Adjustable Universal Display Back Sign**
33" x 26"
13 cm x 10.24 cm
6SWT99996
- C Under Seat Storage System Holder**
9PDAUS1
Used with Adjustable Universal Display 99996
- D FloorLiner™ HP Holder**
9PDA3D1
Used with Adjustable Universal Display 99996

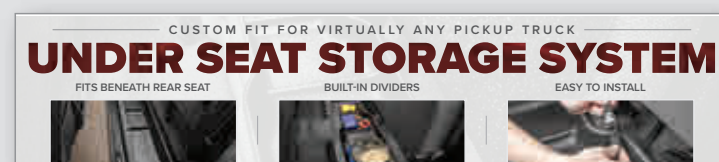

- E Under Seat Storage System Replacement Card**
29" x 6.5"
73.66 cm x 16.51 cm
6PPDUS1
Replacement card available by request



- F FloorLiner™ HP Replacement Card**
6PPDFLHP1
Replacement card available by request



- Universal Mat Rack**
32" x 75" x 21"
81.28 cm x 190.5 cm x 53.34 cm
94UNIVDIS2



- Universal Mat Rack Back Sign Option 1**
26" x 37.5"
66.04 cm x 95.25 cm
6SUNIV4



- Universal Mat Rack Back Sign Option 2**
26" x 37.5"
66.04 cm x 95.25 cm
6SUNIV6



- Universal Modular Shelf Display**
23.125" x 72" x 22.125"
58.74 cm x 182.88 cm x 56.20 cm
WEATHE10181

MARKETING MATERIALS

Trim-to-Fit™ Mat Rack Header Card R AVM MRH2

Replacement card available by request

Trim-to-Fit™ Floor Mat Rolling Rack

20.75" x 67" x 26"
52.71 cm x 170.18 cm x 66.04 cm
99950-AVM



All-Weather™ Floor Mat or Trim-to-Fit™ Floor Mat Rack Header Card R TTF MRH3

Replacement card available by request



Rear Special Order Signage for the Rack Header Card R MRH2

Replacement card available by request

ComfortMat™ Countertop Display 16.625" x 13.125" x 5.5" 42.228 cm x 33.3375 cm x 13.97 cm PDA011CM



Two units shown. Must be ordered as a pair. Together hold 58 sets of mats.

Trim-to-Fit™ Floor Mat Pallet Display

41" x 32.625" x 41.625"
104.14 cm x 82.87 cm x 105.73 cm
69AVMSKID1B



Child Car Seat Protector

16.125" x 13.125" x 4.25"
40.95 cm x 33.33 cm x 10.79 cm
9PDACCSP

MARKETING MATERIALS



IndoorMat™/OutdoorMat™ Display with Casters

19" x 19" x 18"
48.26 cm x 48.26 cm x 45.72 cm
9PDIOM2



Golf Cart Mat Countertop Display

16.625" x 13.125" x 5.5"
42.228 cm x 33.3375 cm x 13.97 cm
PDA011GC

MARKETING MATERIALS



License Plate Rack Display
 9" x 24.5" x 7.5"
 22.86 cm x 62.23 cm x 19.05 cm
99934
 Replacement card available by request #6HWTLPRHC1



BumpStep® Rack Display
 13" x 37.25" x 11.25"
 33.02 cm x 94.62 cm x 28.58 cm
9PDBS1
 Replacement card available by request #6HBS1



CupFone® Countertop Display
 14" x 21.25" x 13.75"
 35.56 cm x 53.97 cm x 34.92 cm
6PDACF1



SunShade™ Countertop Display
 9" x 10" x 6.5"
 22.86 cm x 25.4 cm x 16.51 cm
9PDTS2



Side Window Deflector Display with Casters
 19" x 19" x 18"
 48.26 cm x 48.26 cm x 45.72 cm
9PDSWD1



SunShade™ Display with Casters
 19" x 19" x 18"
 48.26 cm x 48.26 cm x 45.72 cm
9PDTS3



Roll Up Truck Bed Cover Countertop Display
 9.75" x 11.75" x 4.5"
 24.77 cm x 29.85 cm x 11.43 cm
9PDTCB1



Side Window Deflector Countertop Display
 19" x 14.25" x 5.5"
 48.26 cm x 36.2 cm x 13.97 cm
9PDA022

MARKETING MATERIALS



FloorLiner™ Countertop Display
 13.5" x 18.5" x 7.5"
 34.29 cm x 46.99 cm x 19.05 cm
PDA005WT
 Replacement card available by request #6PPD077



Heavy Duty Truck FloorLiner™ Countertop Display
 13.5" x 18.5" x 7.5"
 34.29 cm x 46.99 cm x 19.05 cm
PDA007WT
 Replacement card available by request #6PPD079



FloorLiner™ HP Countertop Display
 Color: Cocoa
 13.5" x 18.5" x 7.5"
 34.29 cm x 46.99 cm x 19.05 cm
PDA009WT
 Replacement card available by request #6PPD078



Cargo/Trunk Liner Countertop Display
 19.75" x 18.25" x 8"
 50.17 cm x 46.36 cm x 20.32 cm
PDA006WT
 Replacement card available by request #6PPD058



All-Weather™ Floor Mat Countertop Display
 11.25" x 17" x 7.5"
 28.58 cm x 43.18 cm x 19.05 cm
PDA003WT
 Replacement card available by request #6PPD040



Trim-to-Fit™ Mat Countertop Display
 12" x 16.75" x 7.25"
 30.48 cm x 42.55 cm x 18.42 cm
PDA004WT
 Replacement card available by request #6PPD071



TechLiner® Countertop Display
 14.75" x 16.75" x 8"
 37.47 cm x 42.55 cm x 20.32 cm
9PDA024
 Replacement card available by request #6PTL1



MudFlap Countertop Display
 9.25" x 15.75" x 8.25"
 23.5 cm x 40.01 cm x 20.96 cm
PDA015
 Replacement card available by request #6PWTMF

MARKETING MATERIALS



Automotive Accessories Banner

48" x 10.5" (4 ft. wide)
121.92 cm x 26.67 cm

6BBAN1

96" x 20" (8 ft. wide)
243.84 cm x 50.8 cm

6BBAN7

Comes with grommets



WeatherTech® Banner

72" x 20"
182.88 cm x 50.8 cm

6S1SS1

Comes with grommets



WeatherTech® Available Stick'n Glide™ Sign

5.875" x 7.875" x 6"

14.92 cm x 17.78 cm x 15.24 cm

6SSTGL1



WeatherTech® Pet Accessories Stick'n Glide™ Sign

5.875" x 7.875" x 6"

14.92 cm x 17.78 cm x 15.24 cm

6SSTGLPFS



It's Your Choice Poster

36" x 24"

91.44 cm x 60.96 cm

6BBAN5

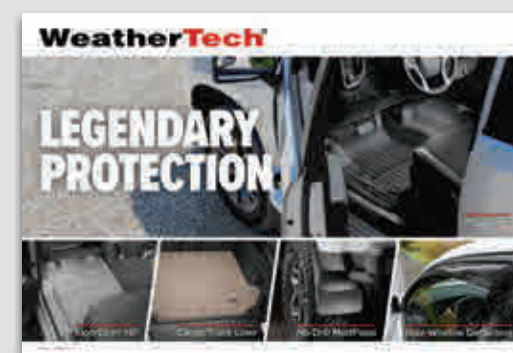

Countertop Mat

19" x 14"

48.26 cm x 35.56 cm

WT CTM 03

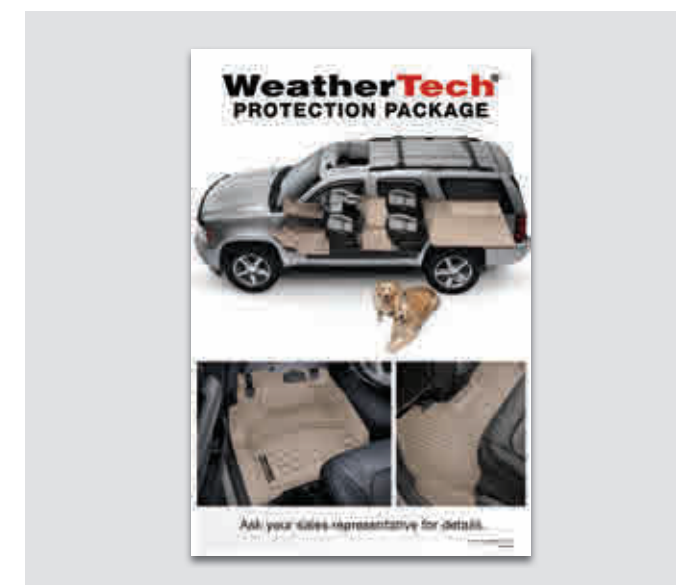

Protection Package Window Cling

8" x 12"

20.32 cm x 30.48 cm

6WSTK4



WeatherTech® Protected Window Cling

6" x 6"

15.24 cm x 15.24 cm

6SWTPROTECT1

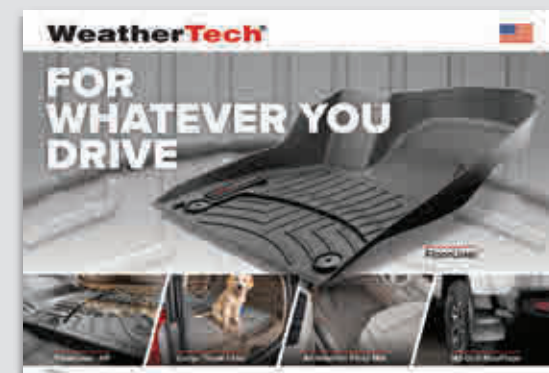

Distributor Poster

39.125" x 27"

99.38 cm x 68.58 cm

6BBAN3



Choice Banner

96" x 48" (8 ft. wide)

243.84 cm x 121.92 cm

6BBAN6

MARKETING MATERIALS

We're ready when you are.
Partner with WeatherTech
on the road ahead!



Distributor Catalog
8.5" x 11"
21.59 cm x 27.94 cm
6GWC2

Distributor Catalog with Holes
8.5" x 11"
21.59 cm x 27.94 cm
6GWC2HOLES



Distributor Catalog Spanish
8.5" x 11"
21.59 cm x 27.94 cm
6GWC3



Wholesale Brochure
3.5" x 8.5"
8.89 cm x 21.59 cm
99932



Truck Bed Cover Brochure
4.25" x 11"
10.79 cm x 27.94 cm
6FTB2



Phone: **800-943-9250 • 630-769-1500**

Email: **Wholesale@WeatherTech.com**

www.WeatherTechWholesale.com



Made in USA

WeatherTechWholesale.com

1 MacNeil Court

Bolingbrook, IL 60440

Phone: 800-943-9250 • 630-769-1500

Fax: 630-769-0300



6GWC2
0223

© 2023 MacNeil IP LLC